

Triplex

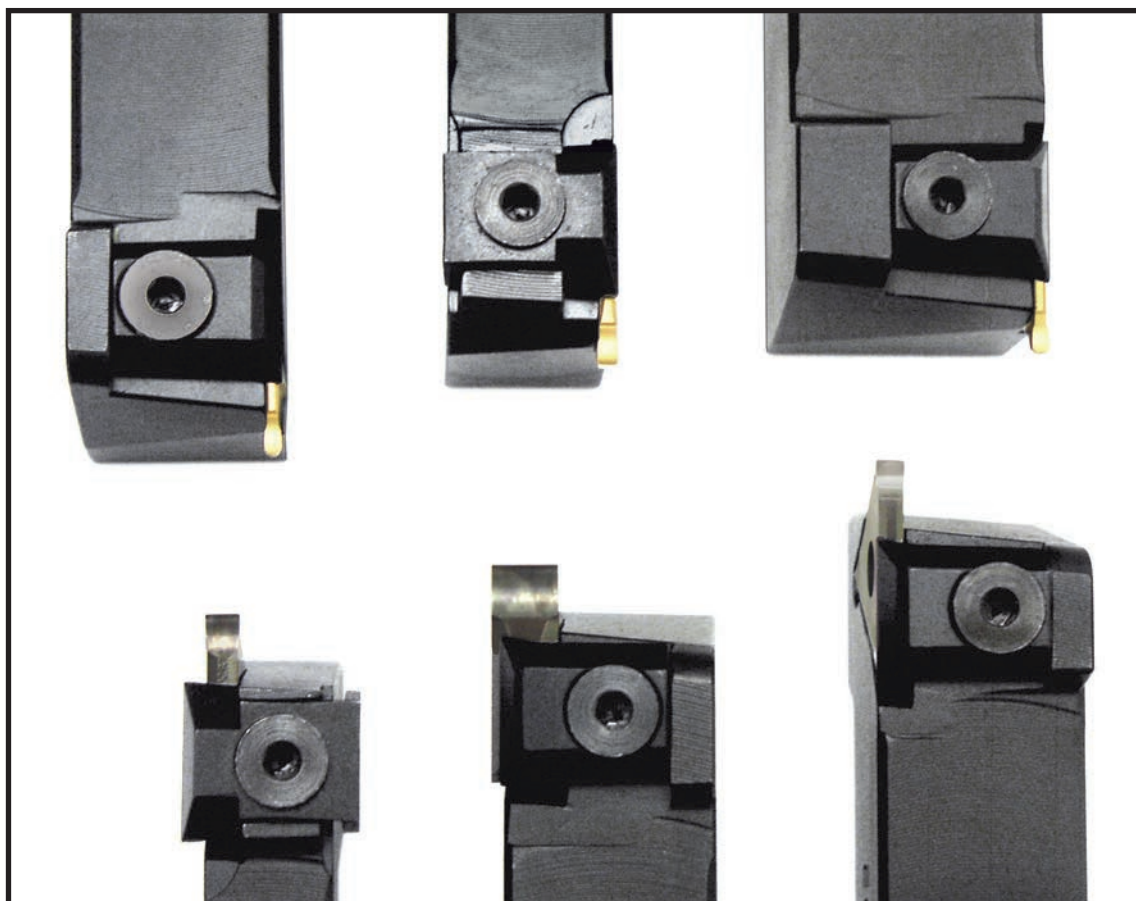

Triplex parting off tools

Triplex grooving tool holder TSH	10E-3
Triplex inserts TSE	10E-4
Triplex inserts TSE ... R.....	10E-5
Triplex inserts TSE ... R.....	10E-6

Other versions and dimensions upon request.
We reserve the right to make technical modifications.
All prices are net in EURO + VAT (value added tax).

Triplex grooving tool holder TSH ...

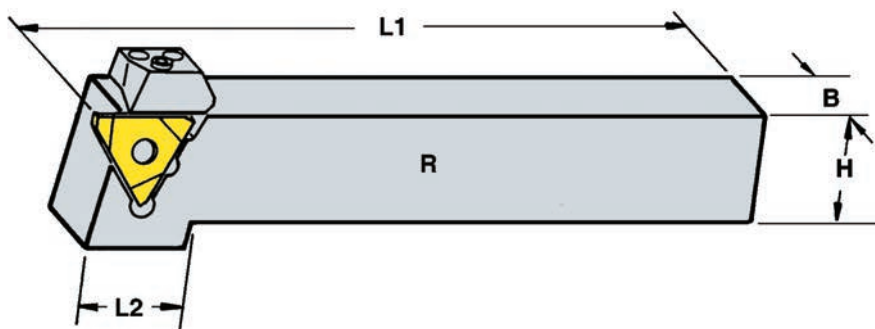

Product group 10E

Order no.	Dimensions in mm							Dis	Price €/ piece
	Clamping range	Grooving depth	L ₁	L ₂	B _{±0.1}	H1 _{±0.1}	H _{js14}		
TSHR-12A	0.5 - 1.9	4	100	24	12	12	25	<input type="checkbox"/>	128.40
TSHR-16A	0.5 - 1.9	4	125	22	16	16	25	<input type="checkbox"/>	119.60
TSHR-20A	0.5 - 1.9	4	125	21	20	20	25	<input type="checkbox"/>	98.70
TSHR-25A	0.5 - 1.9	4	150	-	25	25	25	<input type="checkbox"/>	103.10
TSHR-12B	2.0 - 2.9	6	100	24	12	12	25	<input type="checkbox"/>	128.40
TSHR-16B	2.0 - 2.9	6	125	22	16	16	25	<input type="checkbox"/>	119.60
TSHR-20B	2.0 - 2.9	6	125	21	20	20	25	<input type="checkbox"/>	98.70
TSHR-25B	2.0 - 2.9	6	150	-	25	25	25	<input type="checkbox"/>	103.10
TSHR-12C	3.0 - 3.9	6	100	24	12	12	25	<input type="checkbox"/>	128.40
TSHR-16C	3.0 - 3.9	6	125	22	16	16	25	<input type="checkbox"/>	119.60
TSHR-20C	3.0 - 3.9	6	125	21	20	20	25	<input type="checkbox"/>	98.70
TSHR-25C	3.0 - 3.9	6	150	-	25	25	25	<input type="checkbox"/>	103.10
TSHR-16D	4.0 - 6.3	6	125	22	16	16	25	<input type="checkbox"/>	119.60
TSHR-20D	4.0 - 6.3	6	125	21	20	20	25	<input type="checkbox"/>	98.70
TSHR-25D	4.0 - 6.3	6	150	-	25	25	25	<input type="checkbox"/>	103.10
TSHR-32D	4.0 - 6.3	6	170	-	32	32	32	<input type="checkbox"/>	115.10

Tool holder TSHL also available in left-hand configuration.
For compatible Triplex inserts TSE ... see page 10E-6

Product group 21

Spare parts	for tool holder	Wedge clamp	€/ piece	for tool holder	Wedge clamp	€/ piece
	TSH 06 ...12 ...	PRE 12 TSH06	27.60	TSH 06 ... 20 ...	PRE 20 TSH06	27.60
	TSH 06 ...16 ...	PRE 16 TSH06	27.60	TSH 06 ... 32 ...	PRE 20 TSH06	27.60

★ = ex stock

☆ = short lead time

= upon request

Triplex inserts TSE ...

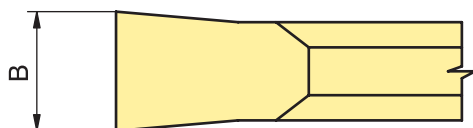
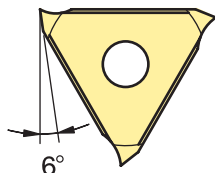

Product group 10F

Order no.	Dimensions in mm		Clamping range	uncoated		Price €/ piece	coated		Price €/ piece
	Slot dimension	B _{0.05}		P20	K10		S320	A310	
TSEA 0,57	0.5	0.57	0.5 - 1.9		<input type="checkbox"/>	15.50		<input type="checkbox"/>	17.60
TSEA 0,67	0.6	0.67	0.5 - 1.9		<input type="checkbox"/>	15.50		<input type="checkbox"/>	17.60
TSEA 0,77	0.7	0.77	0.5 - 1.9		<input type="checkbox"/>	15.50		<input type="checkbox"/>	17.60
TSEA 0,87	0.8	0.87	0.5 - 1.9		<input type="checkbox"/>	15.50		<input type="checkbox"/>	17.60
TSEA 0,97	0.9	0.97	0.5 - 1.9		<input type="checkbox"/>	15.50		<input type="checkbox"/>	17.60
TSEA 1,07	1.0	1.07	0.5 - 1.9	☆		15.50		<input type="checkbox"/>	17.60
TSEA 1,24	1.1	1.24	0.5 - 1.9		<input type="checkbox"/>	15.50		<input type="checkbox"/>	17.60
TSEA 1,44	1.3	1.44	0.5 - 1.9		<input type="checkbox"/>	15.50		<input type="checkbox"/>	17.60
TSEA 1,74	1.6	1.74	0.5 - 1.9		<input type="checkbox"/>	15.50		<input type="checkbox"/>	17.60
TSEA 1,99	1.85	1.99	0.5 - 1.9		<input type="checkbox"/>	15.50		<input type="checkbox"/>	17.60
TSEB 2,29	2.15	2.29	2.0 - 2.9		<input type="checkbox"/>	15.50		<input type="checkbox"/>	17.60
TSEB 2,79	2.65	2.79	2.0 - 2.9		<input type="checkbox"/>	15.50		<input type="checkbox"/>	17.60
TSEC 3,29	3.15	3.29	3.0 - 3.9		<input type="checkbox"/>	16.50		<input type="checkbox"/>	17.60
TSED 4,29	4.15	4.29	4.0 - 6.3		<input type="checkbox"/>	16.80		<input type="checkbox"/>	19.40
TSED 5,29	5.15	5.29	4.0 - 6.3		<input type="checkbox"/>	17.10		<input type="checkbox"/>	19.80

For a compatible Triplex tool holder TSH ... see page 10E-3.

★ = ex stock

☆ = short lead time

= upon request

Triplex inserts TSE ... R

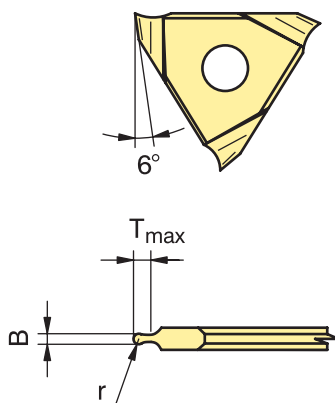

Product group 10F

Order no.	Dimensions in mm			Clamping range	uncoated		Price €/ piece	coated		Price €/ piece
	r	B±0.03	t _{max}		P20	K10		S320	A310	
TSEA 1,3 R 0,2	0.2	1.3	0.3	0.5 - 1.9		<input type="checkbox"/>	20.50		<input type="checkbox"/>	23.60
TSEA 1,3 R 0,5	0.5	1.3	0.3	0.5 - 1.9		<input type="checkbox"/>	20.50		<input type="checkbox"/>	23.60
TSEA 1,3 R 0,6	0.6	1.3	0.3	0.5 - 1.9		<input type="checkbox"/>	20.70		<input type="checkbox"/>	23.90

For a compatible Triplex tool holder TSH ... see page 10E-3.

★ = ex stock

☆ = short lead time

= upon request

Triplex inserts TSE ... R

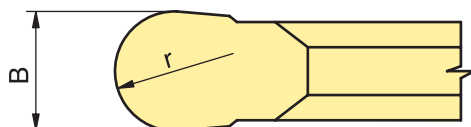
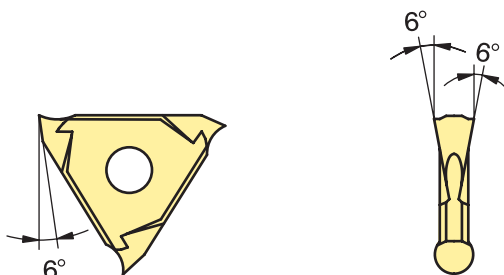

Product group 10F

Order no.	Dimensions in mm			Clamping range	uncoated		Price €/ piece	coated		Price €/ piece
	r	B \pm 0.03			P20	K10		S320	A310	
TSEA 1,6 R 0,8	0.8	1.6		0.5 - 1.9		<input type="checkbox"/>	20.70		<input type="checkbox"/>	23.90
TSEA 1,8 R 0,9	0.9	1.8		0.5 - 1.9		<input type="checkbox"/>	20.50		<input type="checkbox"/>	23.60
TSEA 2,2 R 1,1	1.1	2.2		0.5 - 1.9		<input type="checkbox"/>	20.50		<input type="checkbox"/>	23.60
TSEB 2,8 R 1,4	1.4	2.8		2.0 - 2.9		<input type="checkbox"/>	21.40		<input type="checkbox"/>	24.50
TSEC 3,6 R 1,8	1.8	3.6		3.0 - 3.9		<input type="checkbox"/>	22.10		<input type="checkbox"/>	23.30

For a compatible Triplex tool holder TSH ... see page 10E-3.

★ = ex stock

☆ = short lead time

= upon request